

# RFScanner

## Setup Guide

V260123

Antenna pattern measurement tool diagnostic  
tool on your lab-bench

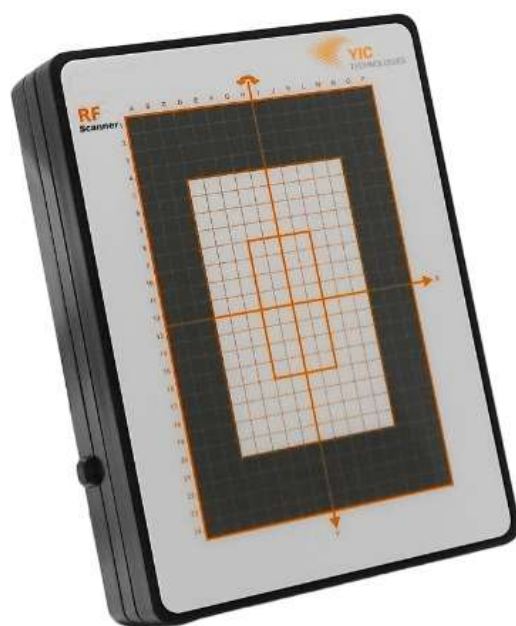

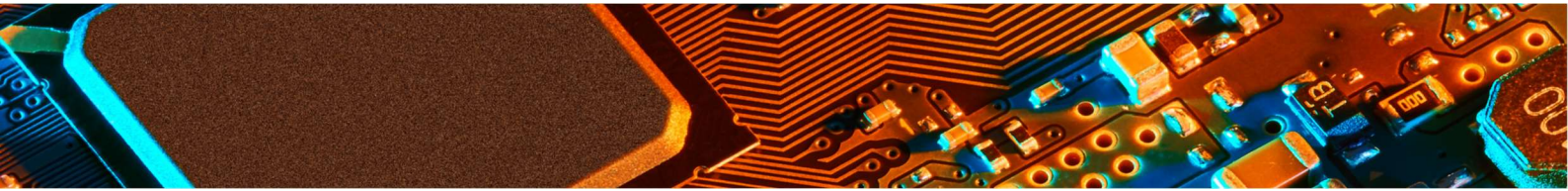

## Disclaimer

### ***Warranty***

The material contained in this user manual is provided “as is” and is subject to being changed, without notice, in future editions. Further to the maximum extent permitted by applicable law, YIC Technologies disclaims all warranties, either expressed or implied, with regard to this user manual and any information contained herein, including but not limited to the implied warranties of merchantability and fitness for a particular purpose. YIC Technologies shall not be liable for errors or for incidental or consequential damages in connection with the furnishing, use, or performance of this document or any information contained herein. Should YIC Technologies and the user have a separate written agreement with warranty terms covering the material in this document that conflict with these terms, the warranty terms in the separate agreement shall control.

## Safety Notices



### ***Caution***

A CAUTION notice denotes a hazard. It calls attention to operating procedure, practice, or the like that, if not correctly performed or adhered to, could result in damage to the product or loss of important data. Do not proceed beyond a CAUTION notice until the indicated conditions are fully understood and met.

### ***Warning***

A WARNING notice denotes a hazard. It calls attention to an operating procedure, practice, or the like that, if not correctly performed or adhered to, could result in personal injury or death. Do not proceed beyond a WARNING notice until the indicated conditions are fully understood and met.

## Contents

1	<b>RFScanner</b>	Antenna Characterization Tool	
2	<b>USB Cable</b>	Connect the PC (laptop or desktop) to the RFScanner	
3	<b>Power</b>	Universal Power Supply	

## Required Components (Supplied by user)

1. PC (Laptop / Desktop): Windows 10/11, must support a USB connection (version 2.0 or higher) and a LAN 10/100/1000 connection or additional USB connection to support Spectrum Analyser.
2. Optional - Supported VNA or Spectrum Analyser for sweep measurements.
3. Optional - The latest version of the Keysight IO Libraries Suite.

## Quick Installation and Checklist

Connect the included 6VDC power supply into the Power supply port of the RFScanner and the B-end of the USB cable to the RFScanner USB Port.



Power supply port and the USB connection port

**Warning:** Use ONLY the 6 VDC power supply that is supplied with RFScanner

1. Download and Install the RFViewer software application from Y.I.C. website: [yictechnologies.com/rfscanner](http://yictechnologies.com/rfscanner).  
The application must always be installed on the C: drive.
2. For Sweep scans, go to <http://www.keysight.com>, download and install the latest version of the Keysight IO Libraries Suite.

## Modes of Operations

### Self-Emitting

If the device under test is self-emitting, connect the PC and RFScanner as per the diagram below; no other equipment is required.

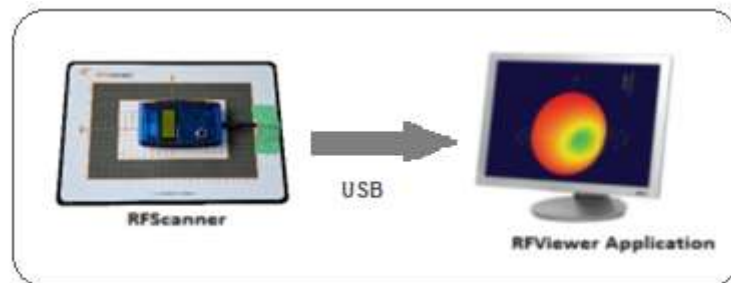

Self-Emitting setup

### Frequency Sweep

If you are testing a passive antenna, connect PC, RFScanner, network analyzer and optionally power sensor as per the diagram below. The power meter is used to measure the power source profile of the VNA, cable and connector up to the antenna under test for the test frequency range to obtain accurate gain and efficiency results.

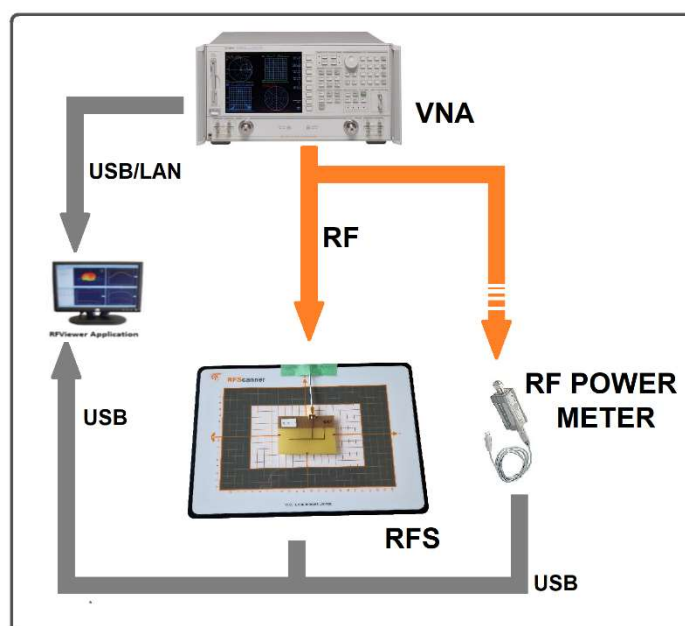



## Frequency Sweep Setup

For compatible network analyzer and power meters with the right hardware, firmware and software please contact Y.I.C. Technologies support at [support@yictechnologies.com](mailto:support@yictechnologies.com)

### Guidelines for Set-up

A proper setup is more critical for frequencies below 1 GHz but is important for measurements done with **RFScanner** at higher frequencies as well. The following guidelines will help reduce the effect of the environment on the measurement results.

1. Platform on which to place the **RFScanner**.
  - Wooden desk is the best possible platform.
  - Metal desks may affect the repeatability of the test results. If you have no other option than a metal desk then please make sure that once you place **RFScanner** on the desk, you don't change its position for the consecutive tests.
  - Anti-static mats are conductive and may affect the repeatability of the test results. Please avoid using antistatic mats under or around **RFScanner**. If you have no other option than using an antistatic mat then please make sure that once you place **RFScanner** on the mat, you don't change its position and you run tests in the same position.
2. Objects around **RFScanner**
  - Leave a minimum 30 cm distance between **RFScanner** and the objects around it.
  - Use wood / Styrofoam to prop up the antenna or wireless device on **RFScanner**. Do not use metal.
  - There may be metal studs in walls. Keep a minimum 30 cm distance from the wall.
  - Desk frame can be made of metal. Keep **RFScanner** at least 30 cm away from any metal frame.
  - Make sure that cables (connection cables between **RFScanner** and PC) don't go over **RFScanner**. To minimize emissions from RF feeding cables, you can use ferrite beads.
3. Objects above **RFScanner**
  - Make sure you don't place **RFScanner** under metal shelves. Large metal reflectors above **RFScanner** may affect the repeatability. For example, fluorescent lights are often hung in large metal boxes. Be cautious about placing **RFScanner** under these light fixtures.

[sales@pcbgt.com.sg](mailto:sales@pcbgt.com.sg)  
[www.pcbgt.com.sg](http://www.pcbgt.com.sg)